

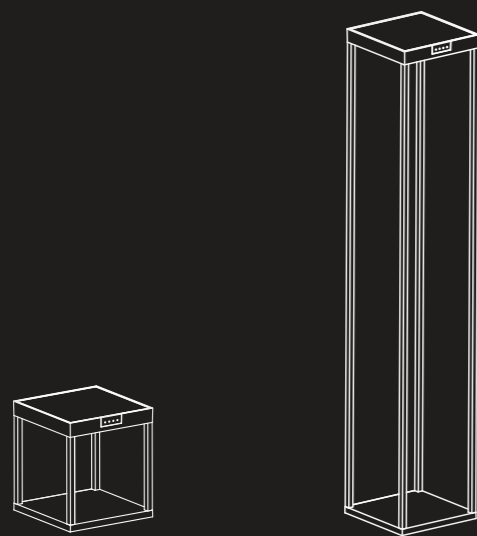

KLEWE
SISTEMASOLARE

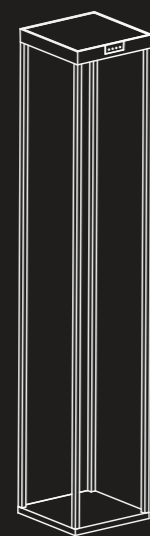

RADIA GROUND — 04



RADIA MEGA — 08

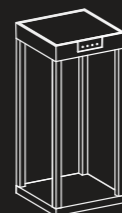

RADIA — 12

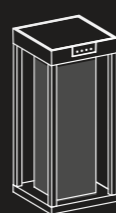

RADIA MOON — 16

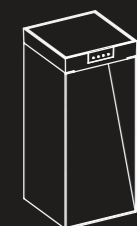

MILIO SIDE — 20

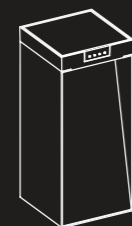

MILIO FULL — 24



ALA — 32



AXIS — 34

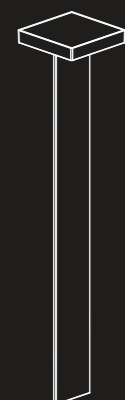

SCOTTY — 42

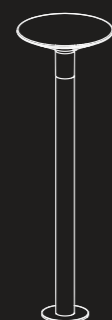

KEOPE — 50



ALA WALL — 28

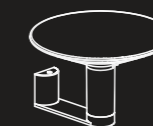

KEOPE WALL — 46



ECOSTEP — 72



HELIOSTEPPER — 38



ALEA — 64



SWING — 68



PLANET B — 52



LINK — 56

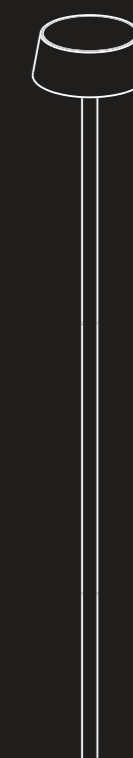

SUNDRESS — 60

RADIA GROUND



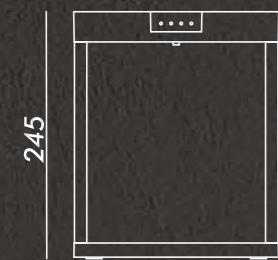
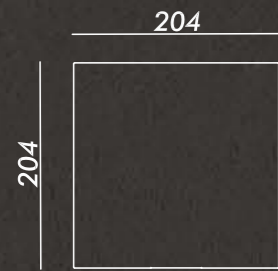

RADIA GROUND
1130110



LED solar lamp
Daylight sensor:
- activate at < 50 lux
- turn off at > 50 lux
IP65

Materials:
- die-casting aluminium, extruded aluminium
- thermosetting epoxy polyester powder coating
- stainless steel screws
- clear polycarbonate diffuser
Salt spray corrosion test: 800h

Charging time: 8-10h
Working time: 23-25h
Power: 3W
Lithium Battery: 2*2200 mAh (replaceable)
Battery level indicator
Solar panel:
- 4.5W monocrystalline
- tempered glass
LED: Lumileds 4014
Light colour temperature: 3000K
CRI>80

Inner box size: 27.5 x 27.5 x 32.5 cm
Master: 4 pieces
Master size: 56.5 x 56.5 x 34 cm
Net weight: 7.6 kg
Gross weight: 11.4 kg

RADIA GROUND

1130110

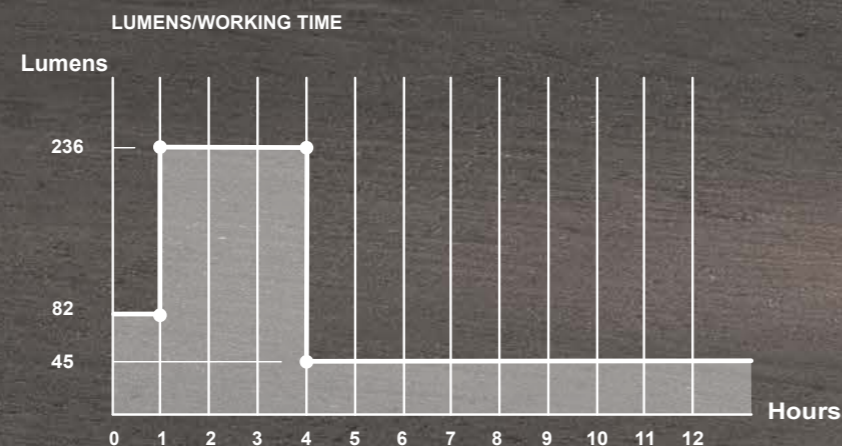
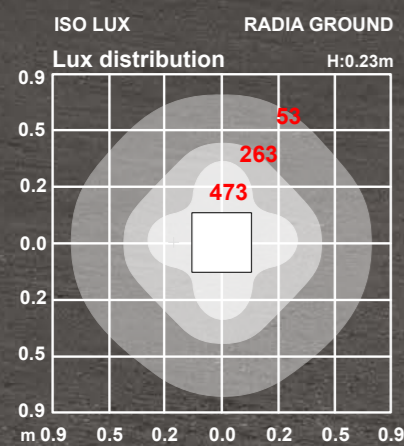

RADIA MEGA



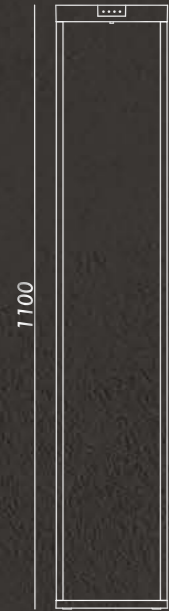
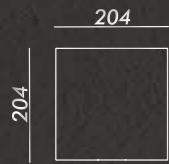

RADIA MEGA
1130210



LED solar lamp
Daylight sensor:
- activate at < 50 lux
- turn off at > 50 lux
IP65 

Materials:
- die-casting aluminium, extruded aluminium
- thermosetting epoxy polyester powder coating
- stainless steel screws
- clear polycarbonate diffuser
Salt spray corrosion test: 800h

Charging time: 8-10h
Working time: 23-25h
Power: 3W
Lithium Battery: 2*2200 mAh (replaceable)
Battery level indicator
Solar panel:
- 4.5W monocrystalline
- tempered glass
LED: Lumileds 4014
Light colour temperature: 3000K
CRI>80

Inner box size: 22 x 11 x 109 cm
Master: 2 pieces
Master size: 23.5 x 23.5 x 110.5 cm
Net weight: 9.8 kg
Gross weight: 13.7 kg

RADIA MEGA
1130210

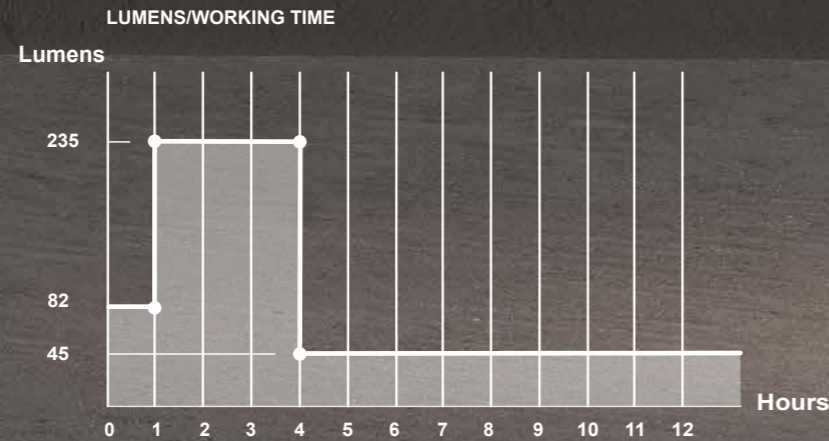
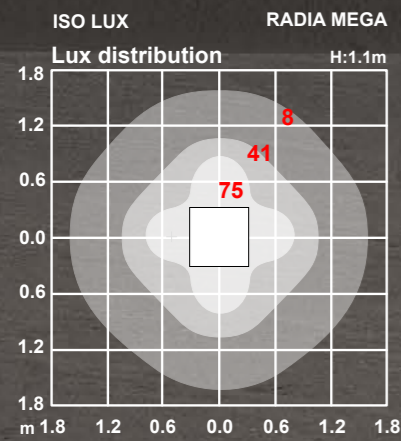



RADIA



LED solar lamp
 Daylight sensor:
 - activate at < 50 lux
 - turn off at > 50 lux
 IP65

Materials:
 - die-casting aluminium, extruded aluminium
 - thermosetting epoxy polyester powder coating
 - stainless steel screws
 - clear polycarbonate diffuser
 Salt spray corrosion test: 800h

Charging time: 6-8h
 Working time: 13-15h
 Power: 2.2W
 Lithium Battery: 2200 mAh (replaceable)
 Battery level indicator
 Solar panel:
 - 2.5W monocrystalline
 - tempered glass
 LED: Lumileds 4014
 Light colour temperature: 3000K
 CRI>80

RADIA MINI:
 Inner box size: 20.5 x 20.5 x 43.5 cm
 Master: 4 pieces
 Master size: 42.5 x 42.5 x 45 cm
 Net weight: 6.8 kg
 Gross weight: 9.8 kg

RADIA MAXI:
 Inner box size: 20.5 x 20.5 x 58.5 cm
 Master: 4 pieces
 Master size: 42.5 x 42.5 x 60 cm
 Net weight: 7.6 kg
 Gross weight: 10.4 kg

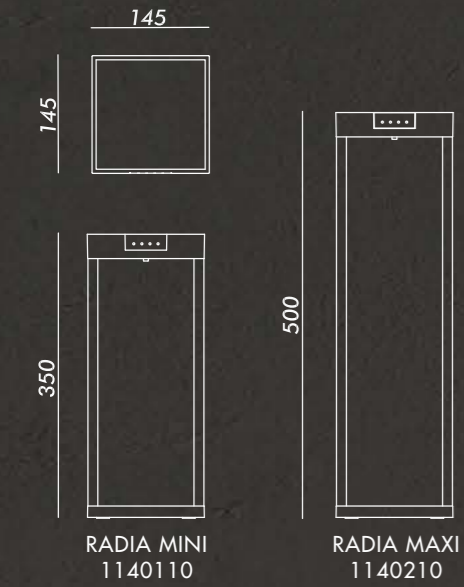

Optional Accessories: Stainless steel spike

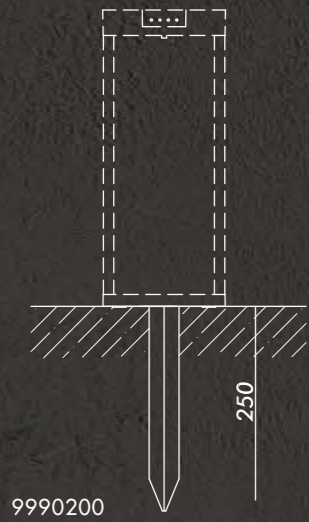

RADIA MAXI
1140210

RADIA MINI
1140110

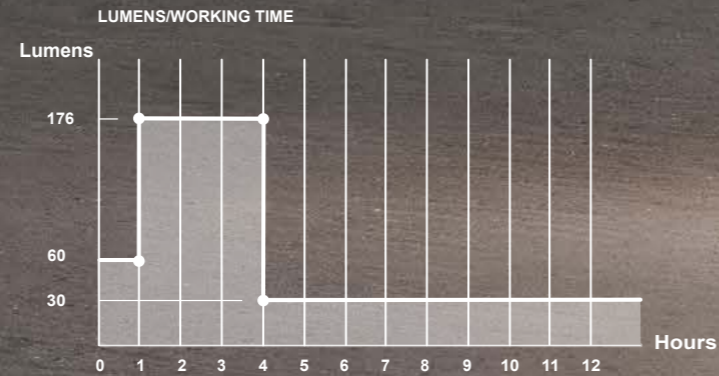
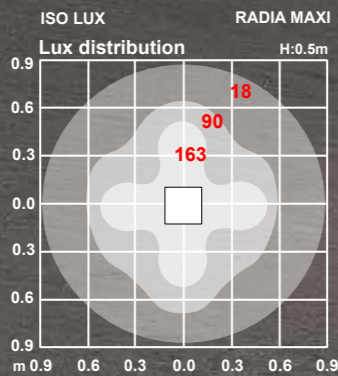
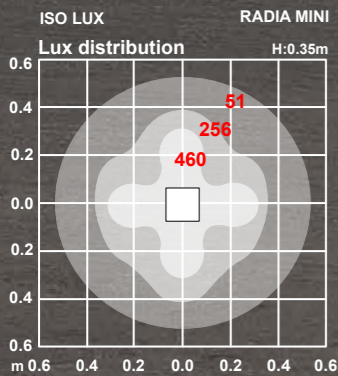

RADIA MOON





LED solar lamp
 Daylight sensor:
 - activate at < 50 lux
 - turn off at > 50 lux
 IP65

Materials:
 - die-casting aluminium, extruded aluminium
 - thermosetting epoxy polyester powder coating
 - stainless steel screws
 - opal polycarbonate diffuser
 Salt spray corrosion test: 800h

Charging time: 6-8h
 Working time: 13-15h
 Power: 2.2W
 Lithium Battery: 2200 mAh (replaceable)
 Battery level indicator
 Solar panel:
 - 2.5W monocrystalline
 - tempered glass
 LED: Lumileds 4014
 Light colour temperature: 3000K
 CRI>80

RADIA MOON MINI:
 Inner box size: 20.5 x 20.5 x 43.5 cm
 Master: 4 pieces
 Master size: 42.5 x 42.5 x 45 cm
 Net weight: 8 kg
 Gross weight: 12.2 kg

RADIA MOON MAXI:
 Inner box size: 20.5 x 20.5 x 58.5 cm
 Master: 4 pieces
 Master size: 42.5 x 42.5 x 60 cm
 Net weight: 8.8 kg
 Gross weight: 14.6 kg

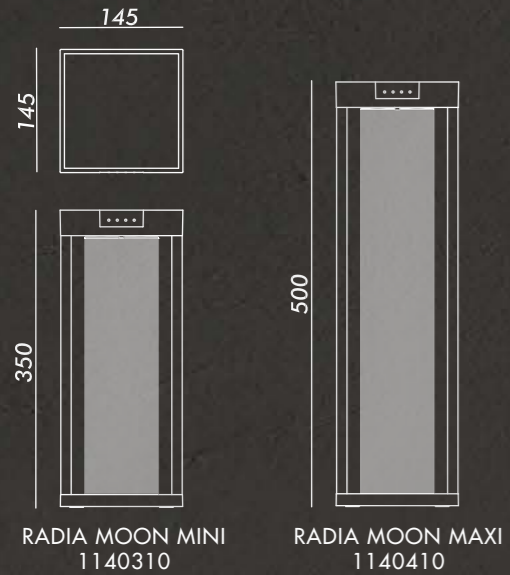

Optional Accessories: Stainless steel spike

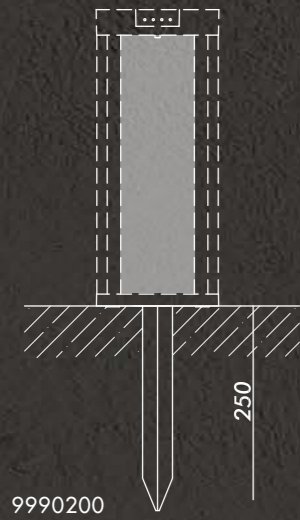

RADIA MOON MAXI
1140410

RADIA MOON MINI
1140310

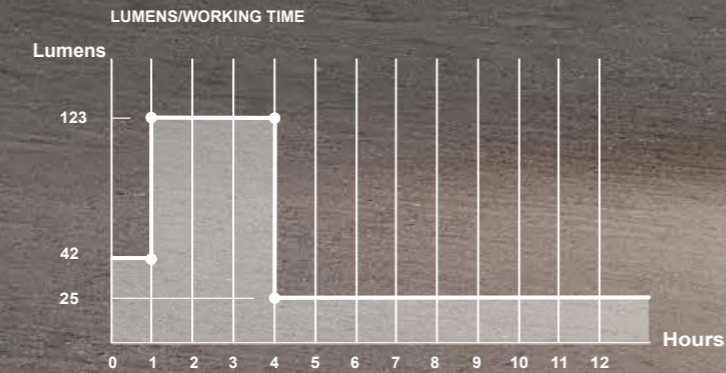
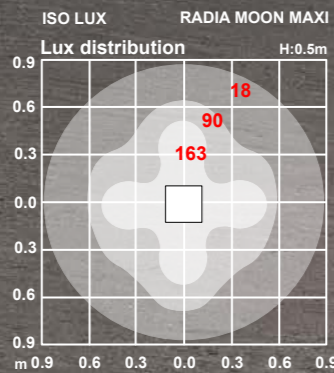
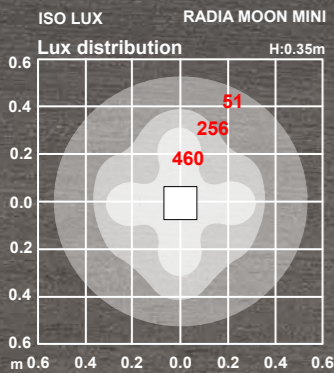

MILIO SIDE



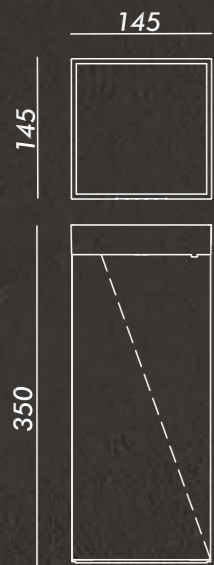

MILIO SIDE
1150110

Optional Accessories: Stainless steel spike

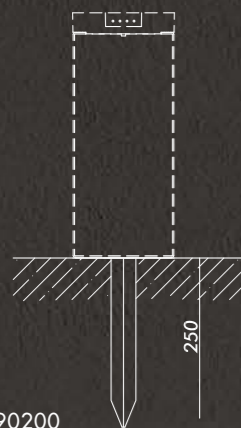

9990200



LED solar lamp
Daylight sensor:
- activate at < 50 lux
- turn off at > 50 lux
IP65

Materials:
- die-casting aluminium, extruded aluminium
- thermosetting epoxy polyester powder coating
- stainless steel screws
- clear polycarbonate diffuser
Salt spray corrosion test: 800h

Charging time: 6-8h
Working time: 13-15h
Power: 2.2W
Lithium Battery: 2200 mAh (replaceable)
Battery level indicator
Solar panel:
- 2.5W monocrystalline
- tempered glass
LED: Lumileds 4014
Light colour temperature: 3000K
CRI>80

Inner box size: 20.5 x 20.5 x 43.5 cm
Master: 4 pieces
Master size: 42.5 x 42.5 x 45 cm
Net weight: 6.8 kg
Gross weight: 9.8 kg

MILIO SIDE
1150110

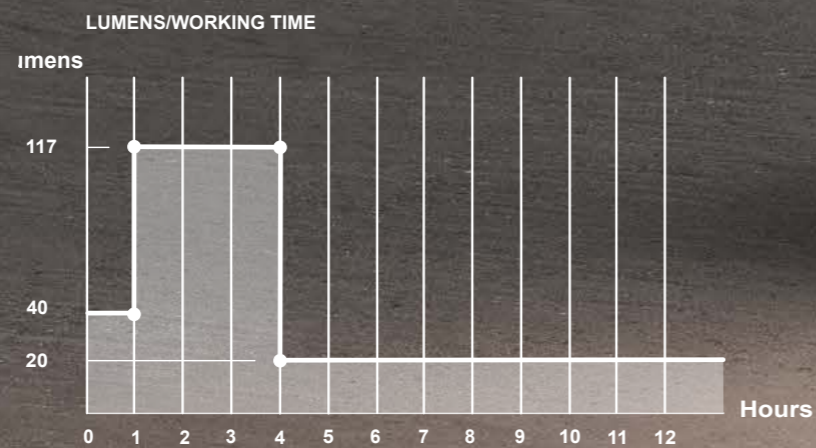
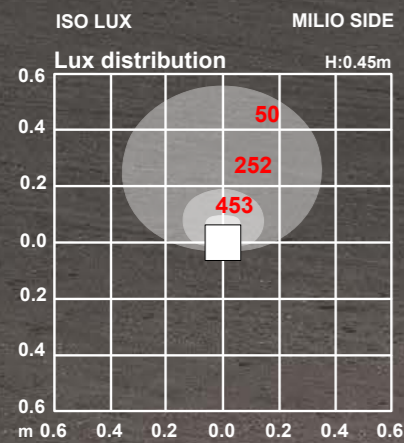

MILIO FULL

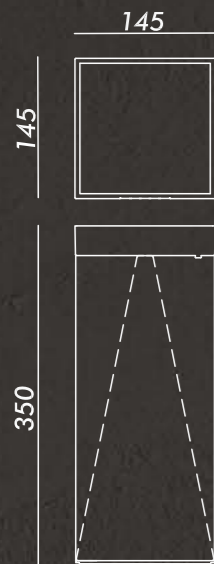

MILIO FULL
1150210

Optional Accessories: Stainless steel spike

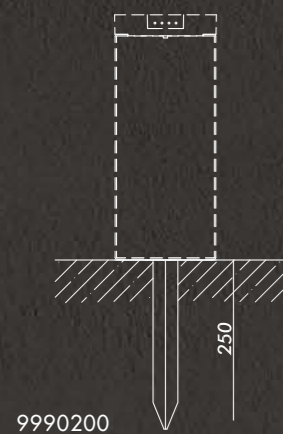

LED solar lamp
Daylight sensor:
- activate at < 50 lux
- turn off at > 50 lux
IP65

Materials:
- die-casting aluminium, extruded aluminium
- thermosetting epoxy polyester powder coating
- stainless steel screws
- clear polycarbonate diffuser
Salt spray corrosion test: 800h

Charging time: 6-8h
Working time: 13-15h
Power: 2.2W
Lithium Battery: 2200 mAh (replaceable)
Battery level indicator
Solar panel:
- 2.5W monocrystalline
- tempered glass
LED: Lumileds 4014
Light colour temperature: 3000K
CRI>80

Inner box size: 20.5 x 20.5 x 43.5 cm
Master: 4 pieces
Master size: 42.5 x 42.5 x 45 cm
Net weight: 6.8 kg
Gross weight: 9.8 kg

MILIO FULL

1150210

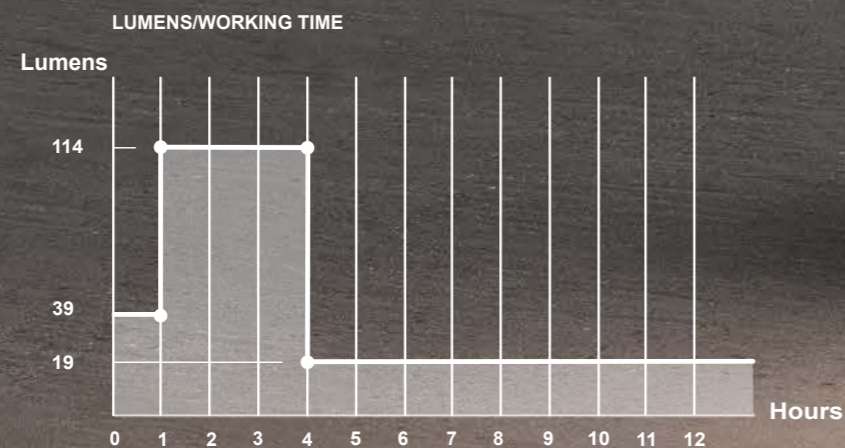
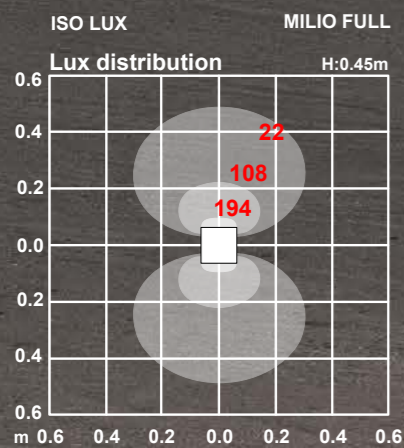

ALA

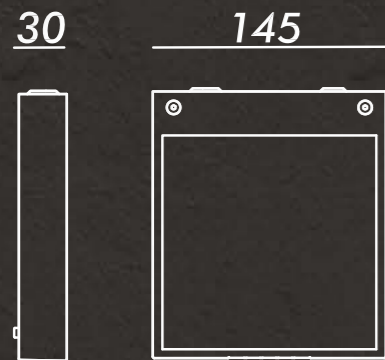

ALA WALL
1160310



LED solar lamp

Daylight sensor:

- activate at < 50 lux
- turn off at > 50 lux

IP65

Materials:

- die-casting aluminium, extruded aluminium
 - thermosetting epoxy polyester powder coating
 - stainless steel screws
 - clear polycarbonate diffuser
- Salt spray corrosion test: 800h

Charging time: 6-8h

Working time: 13-15h

Power: 2.2W

Lithium Battery: 2200 mAh (replaceable)

Battery level indicator

Solar panel:

- 2.5W monocrystalline
- tempered glass

LED: Lumileds 4014

Light colour temperature: 3000K

CRI>80

Inner box size: 20 x 6 x 19 cm

Master: 12 pieces

Master size: 41.5 x 38 x 20.5 cm

Net weight: 10.7 kg

Gross weight: 14 kg

ALA WALL
1160310

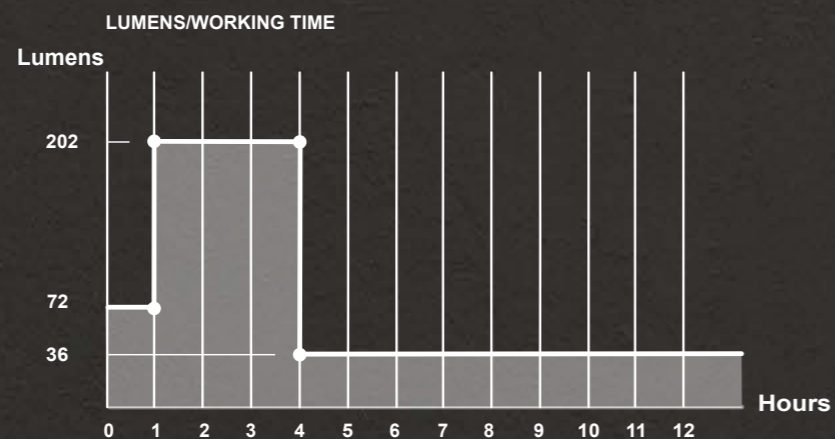
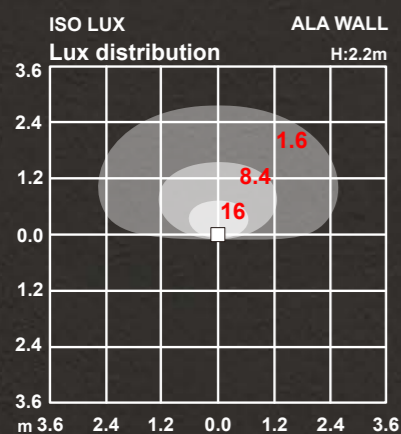



LED solar lamp
 Daylight sensor:
 - activate at < 50 lux
 - turn off at > 50 lux
 IP65

Materials:
 - die-casting aluminium, extruded aluminium
 - thermosetting epoxy polyester powder coating
 - stainless steel screws
 - clear polycarbonate diffuser
 Salt spray corrosion test: 800h

Charging time: 6-8h
 Working time: 13-15h
 Power: 2.2W
 Lithium Battery: 2200 mAh (replaceable)
 Battery level indicator
 Solar panel:
 - 2.5W monocrystalline
 - tempered glass
 LED: Lumileds 4014
 Light colour temperature: 3000K
 CRI>80

ALA MINI:
 Inner box size: 24.5 x 21 x 48.5 cm
 Master: 4 pieces
 Master size: 50.5 x 50 x 43.5 cm
 Net weight: 6.8 kg
 Gross weight: 10.3 kg

ALA MAXI:
 Inner box size: 24.5 x 21 x 73.5 cm
 Master: 4 pieces
 Master size: 75 x 50.5 x 43.5 cm
 Net weight: 8.4 kg
 Gross weight: 12.6 kg

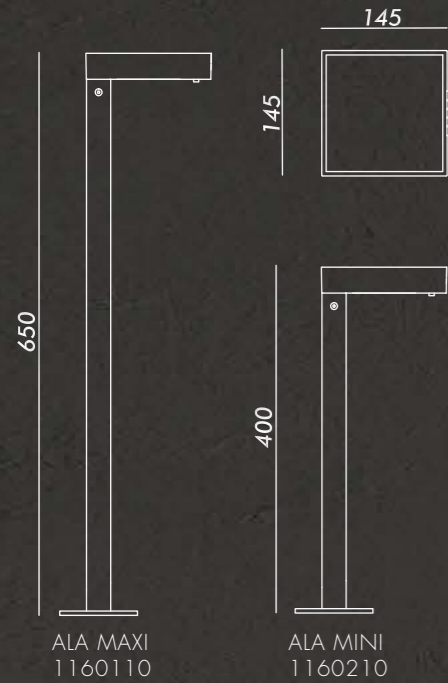

Optional Accessories: Stainless steel spike

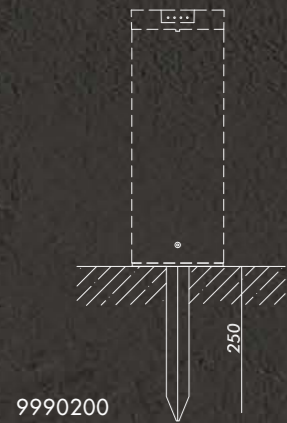

ALA MAXI
 1160110

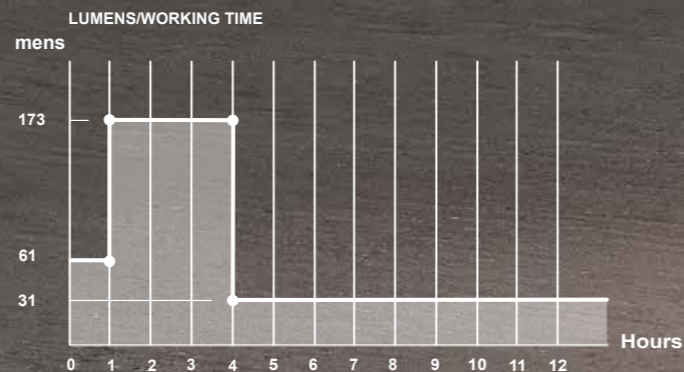
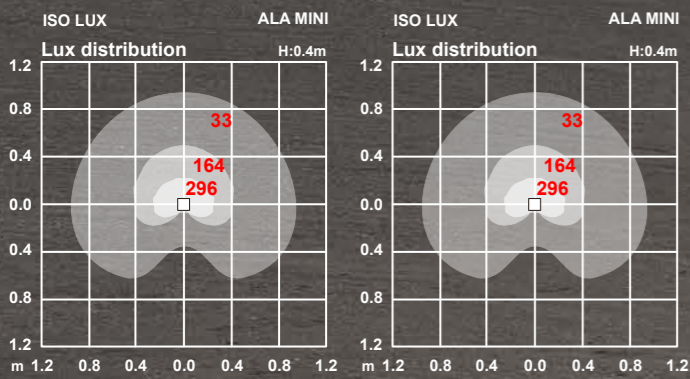



AXIS

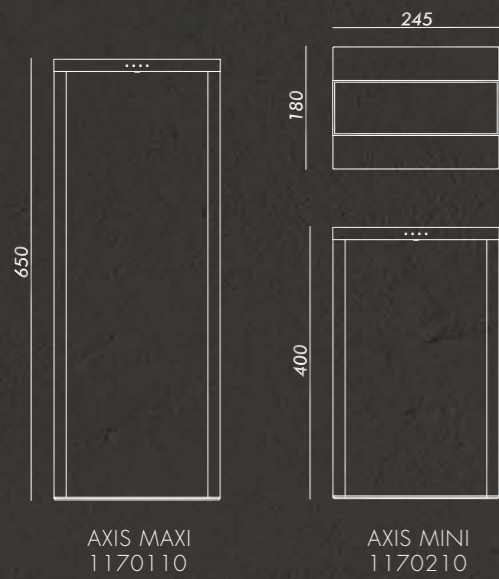

LED solar lamp
 Daylight sensor:
 - activate at < 50 lux
 - turn off at > 50 lux
 IP65 

Materials:
 - die-casting aluminium, extruded aluminium
 - thermosetting epoxy polyester powder coating
 - stainless steel screws
 - clear glass diffuser
 Salt spray corrosion test: 800h

Charging time: 10-12h
 Working time: 19-21h
 Power: 2.2W
 Lithium Battery: 3000 mAh (replaceable)
 Battery level indicator
 Solar panel:
 - 2.5W monocrystalline
 - tempered glass
 LED: Lumileds 4014
 Light colour temperature: 3000K
 CRI>80

AXIS MINI:
 Inner box size: 31.5 x 26 x 48 cm
 Master: 2 pieces
 Master size: 53.5 x 49.5 x 33 cm
 Net weight: 4.6 kg
 Gross weight: 7.2 kg

AXIS MAXI:
 Inner box size: 31.5 x 26 x 73 cm
 Master: 2 pieces
 Master size: 74.5 x 53.5 x 33 cm
 Net weight: 5.7 kg
 Gross weight: 9.1 kg

AXIS MAXI

1170110

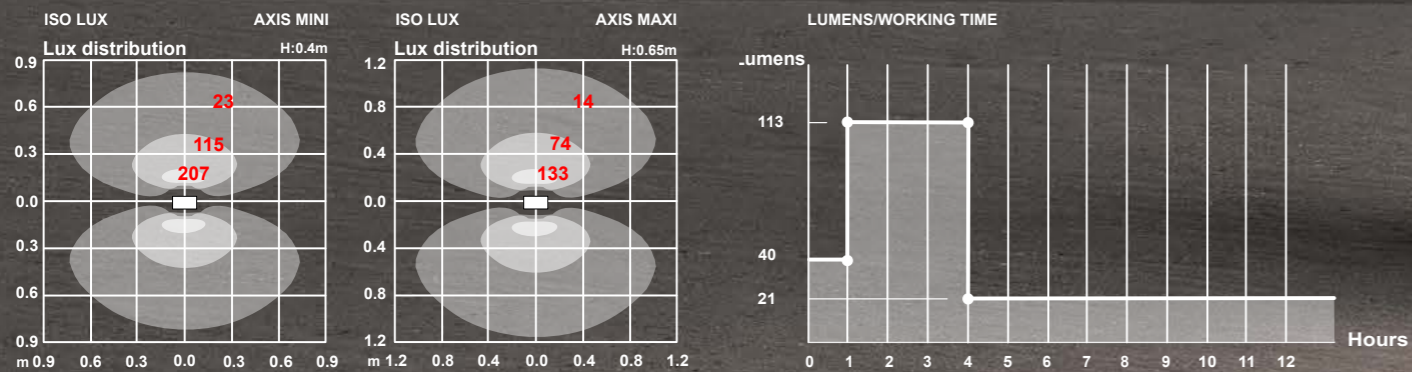

HELIOSTEPPER

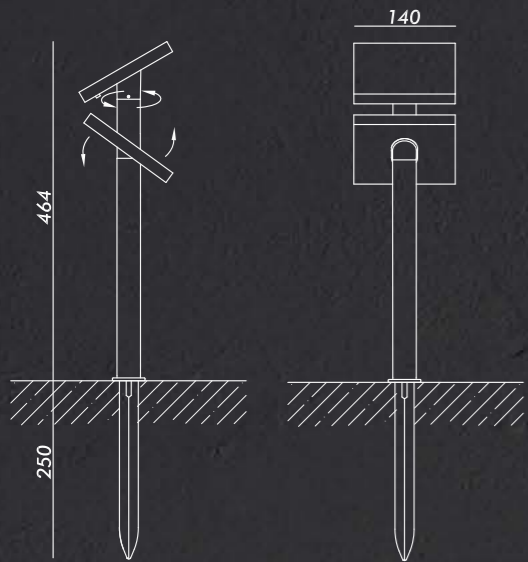

HELIOSTEPPER
1200110

Optional Accessories: Base

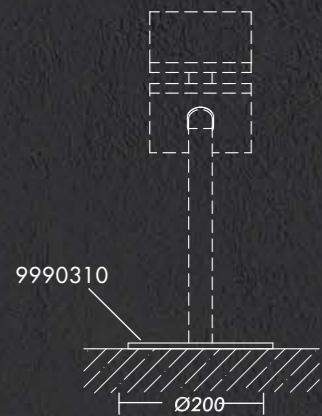

LED solar lamp
Daylight sensor:
- activate at < 50 lux
- turn off at > 50 lux
IP54

Materials:
- die-casting aluminium, extruded aluminium
- thermosetting epoxy polyester powder coating
- stainless steel screws
- clear polycarbonate diffuser
Salt spray corrosion test: 800h

Charging time: 6-8h
Working time: 13-15h
Power: 2.2W
Lithium Battery: 2200 mAh (replaceable)
Solar panel:
- 2.5W monocrystalline
- tempered glass
LED: Lumileds 4014
Light colour temperature: 3000K
CRI>80

Inner box size: 18.5x 18.5 x 53 cm
Master: 6 pieces
Master size: 57 x 38.5 x 54.5 cm
Net weight: 7.2 kg
Gross weight: 11.5 kg



HELIOSTEPPER
1200110

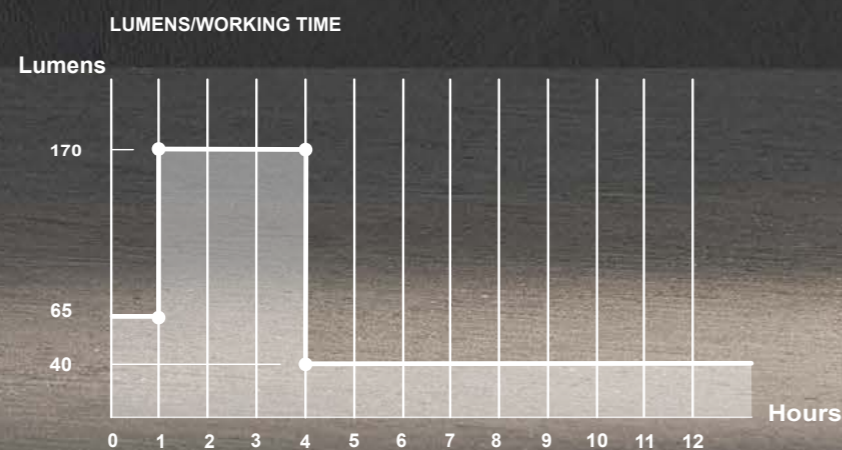
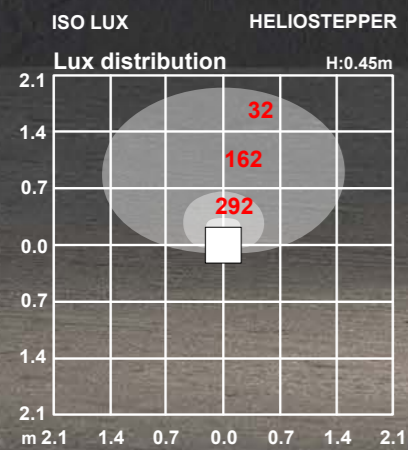



SCOTTY

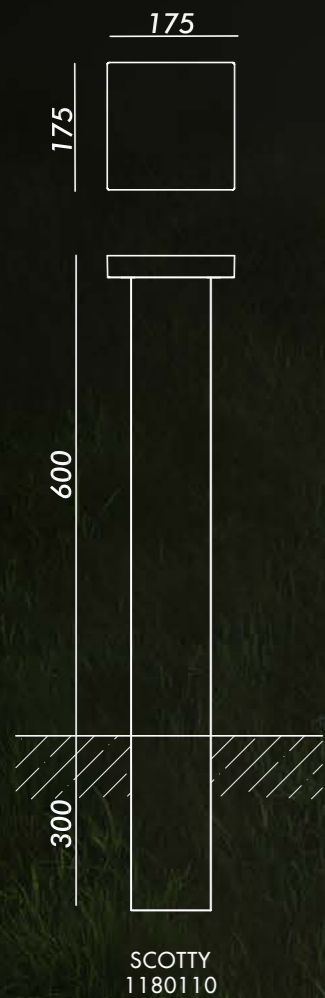

LED solar lamp
Daylight sensor:
- activate at < 50 lux
- turn off at > 50 lux
IP65

Materials:
- die-casting aluminium
- thermosetting epoxy polyester powder coating
- stainless steel screws
- clear glass diffuser
- transparent tempered glass, 8mm thickness
Salt spray corrosion test: 800h

Charging time: 12-13h
Working time: 26-28h
Power: 2.6W
Lithium Battery: 2*2200 mAh (replaceable)
Solar panel:
- 4W monocrystalline
- tempered glass
LED: Lumileds 2835
Light colour temperature: 3000K
CRI>80

Inner box size: 18.5 x 9 x 92.5 cm
Master: 2 pieces
Master size: 20 x 20 x 94 cm
Net weight: 6.6 kg
Gross weight: 9.3 kg

SCOTTY
1180110

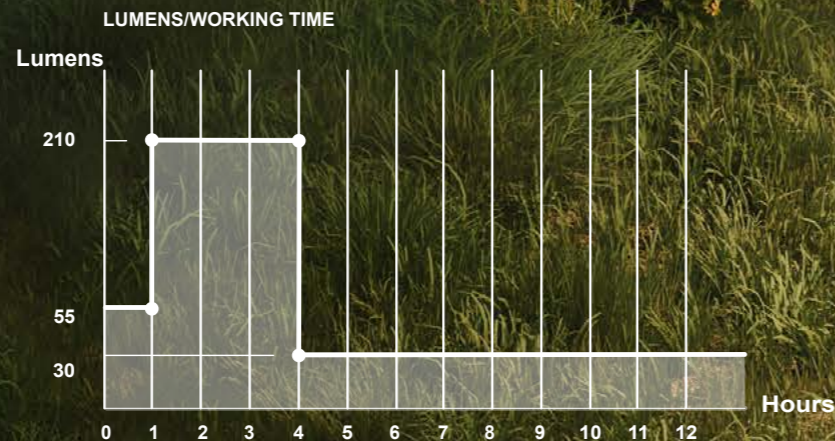
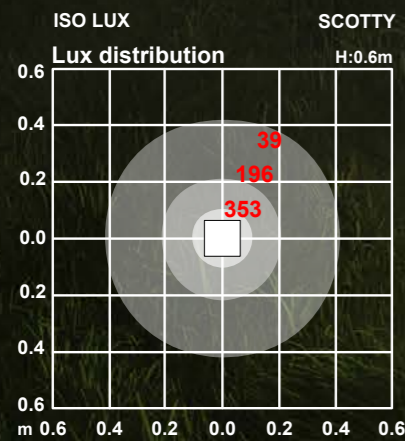



KEOPE

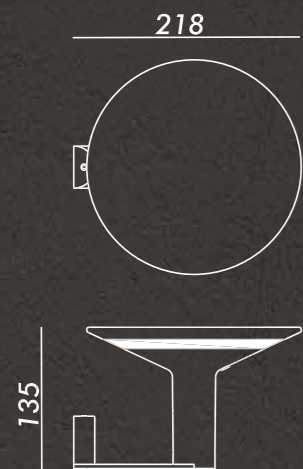

KEOPE WALL
1120210



LED solar lamp
Daylight sensor:
- activate at < 50 lux
- turn off at > 50 lux
IP65

Materials:
- die-casting aluminium
- thermosetting epoxy polyester powder coating
- stainless steel screws
- clear polycarbonate diffuser
Salt spray corrosion test: 800h

Charging time: 10-12h
Working time: 23-25h
Power: 3W
Lithium Battery: 2*2200 mAh (replaceable)
Battery level indicator
Solar panel:
- 3.5W monocrystalline
- tempered glass
LED: Lumileds 4014
Light colour temperature: 3000K
CRI>80

Inner box size: 25 x 24 x 17.5 cm
Master: 6 pieces
Master size: 54.5 x 49.5 x 26.5 cm
Net weight: 6.4 kg
Gross weight: 10.6 kg

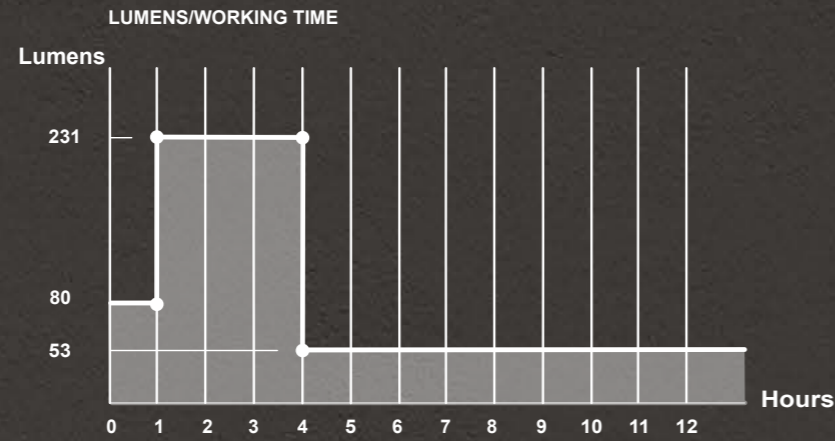
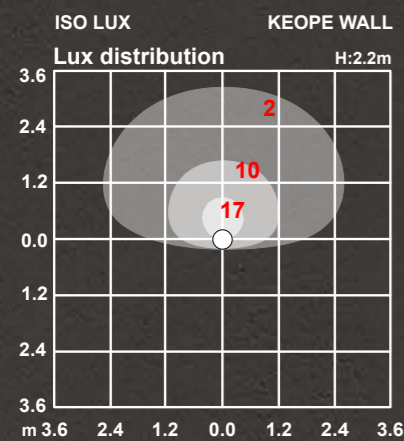

KEOPE WALL
1120210

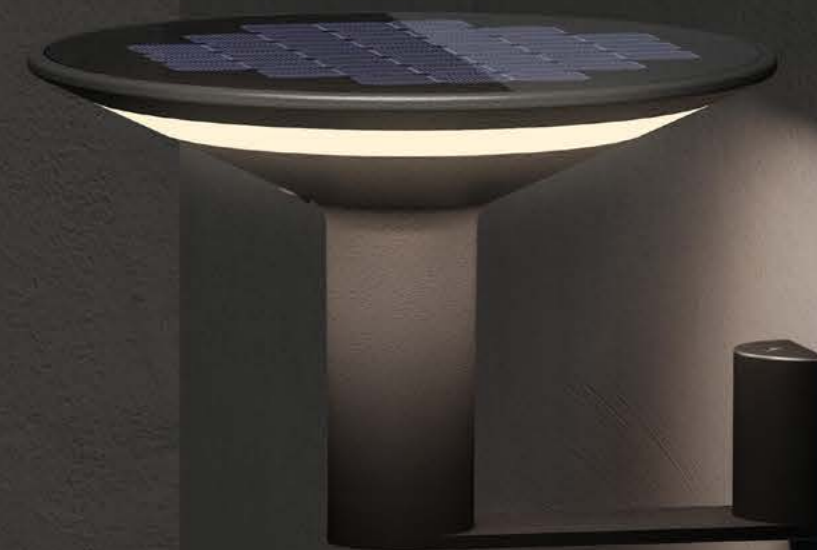

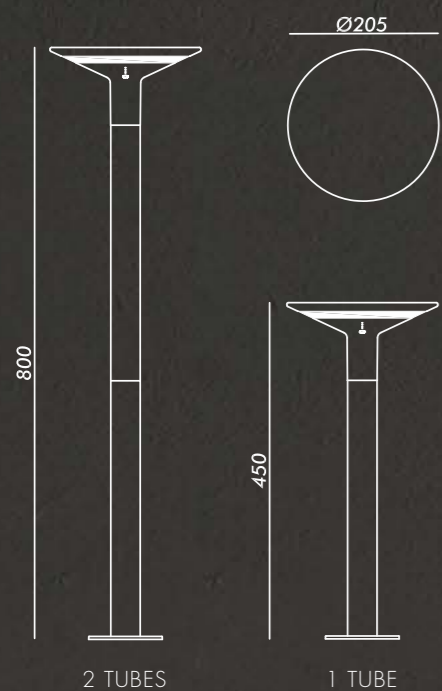

KEOPE
1120110

Optional Accessories: Stainless steel spike

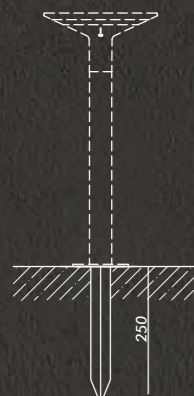

9990200



LED solar lamp
Daylight sensor:
- activate at < 50 lux
- turn off at > 50 lux
IP65

Materials:
- die-casting aluminium, extruded aluminium
- thermosetting epoxy polyester powder coating
- stainless steel screws
- clear polycarbonate diffuser
Salt spray corrosion test: 800h

Charging time: 10-12h
Working time: 23-25h
Power: 3W
Lithium Battery: 2*2200 mAh (replaceable)
Battery level indicator
Solar panel:
- 3.5W monocrystalline
- tempered glass
LED: Lumileds 4014
Light colour temperature: 3000K
CRI>80

Inner box size: 38.5 x 24 x 15.5 cm
Master: 4 pieces
Master size: 64 x 40 x 25.5 cm
Net weight: 6.6 kg
Gross weight: 10.2 kg

KEOPE
1120110

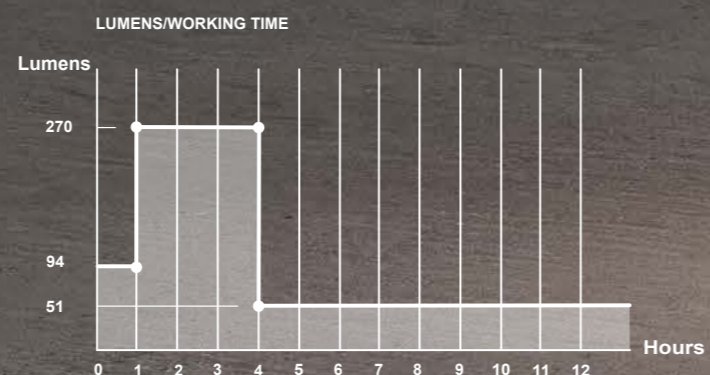
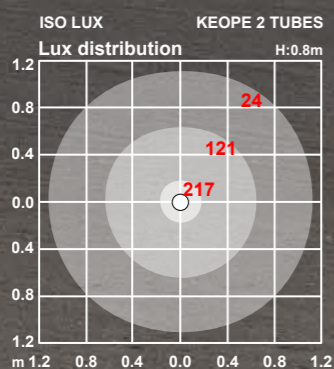
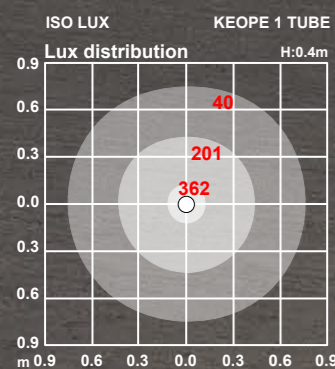
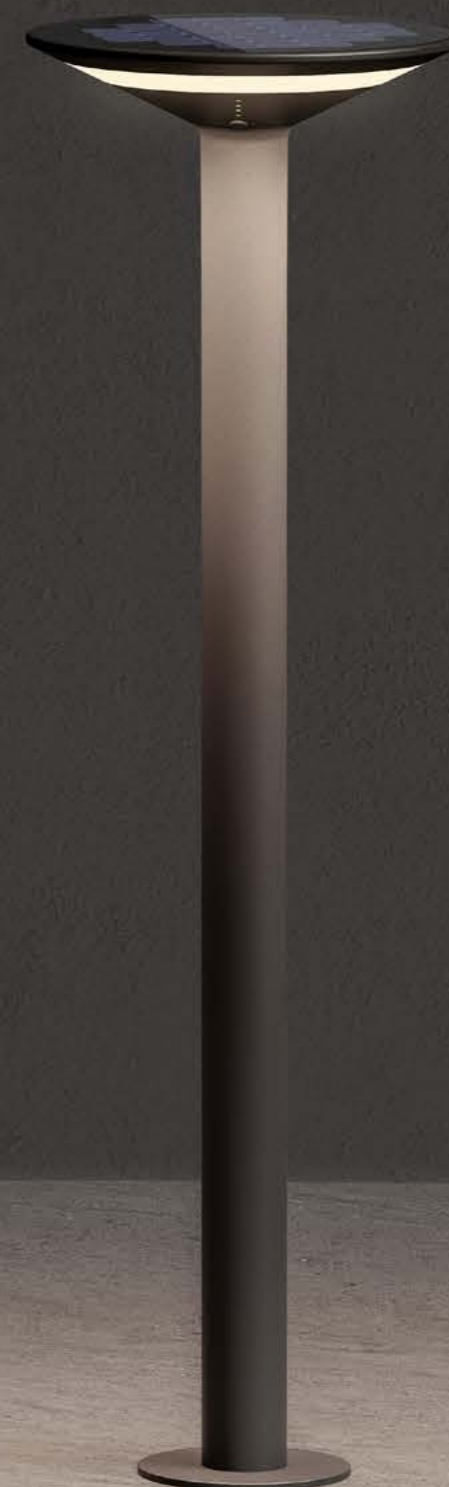

Design: Franco Pagliarini

PLANET B

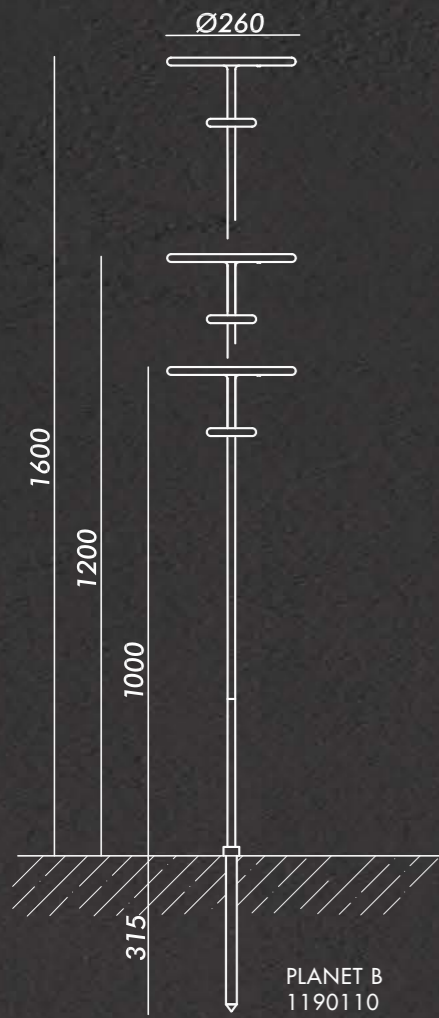

LED solar lamp
Daylight sensor:
- activate at < 50 lux
- turn off at > 50 lux
IP54



Materials:
- die-casting aluminium, extruded aluminium
- thermosetting epoxy polyester powder coating
- stainless steel screws
- clear polycarbonate diffuser
Salt spray corrosion test: 800h

Charging time: 6-8h
Working time: 23-25h
Power: 3W
Lithium Battery: 3600 mAh (replaceable)
Solar panel:
- 4.5W monocrystalline
- tempered glass
LED: Lumileds 4014
Light colour temperature: 3000K
CRI>80

Inner box size: 63 x 30 x 12.5 cm
Master: 2 pieces
Master size: 64.5 x 31.5 x 27 cm
Net weight: 4.5 kg
Gross weight: 7.2 kg

PLANET B
1190110

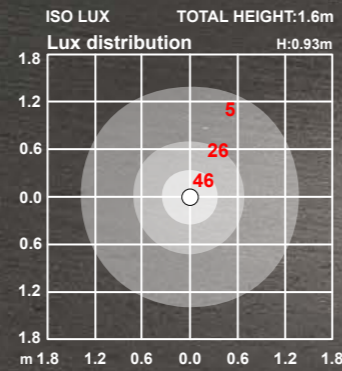
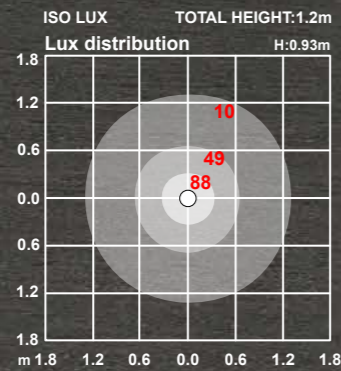
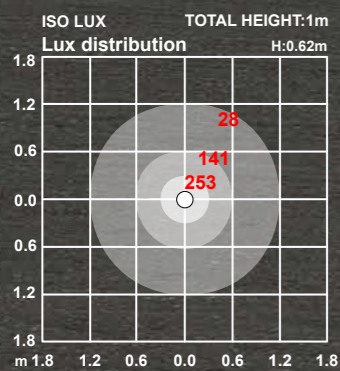
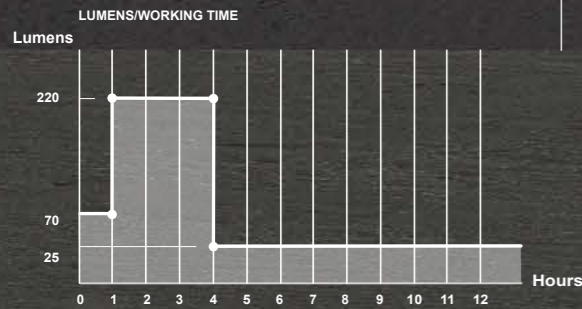



LINK



Optional Accessories: Pole 9990110



LED solar lamp
Daylight sensor:
- activate at < 50 lux
- turn off at > 50 lux
IP54

Materials:
- die-casting aluminium, extruded aluminium
- thermosetting epoxy polyester powder coating
- stainless steel screws
- clear tempered glass diffuser
Salt spray corrosion test: 800h

Charging time: 8-10h
Working time: 34-36h
Power: 5W
Lithium Battery: 4*2200 mAh (replaceable)
Solar panel:
- 9W monocrystalline
- tempered glass
LED: Lumileds 4014
Light colour temperature: 3000K
CRI>80

Inner box size: 28.5 x 11.5 x 47.5 cm
Master: 4 pieces
Master size: 49 x 48 x 30 cm
Net weight: 8.4 kg
Gross weight: 11 kg

LINK
1230110

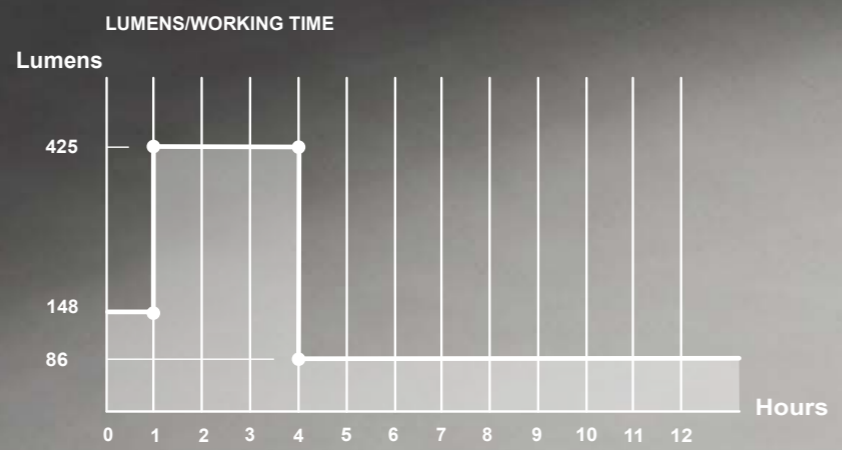
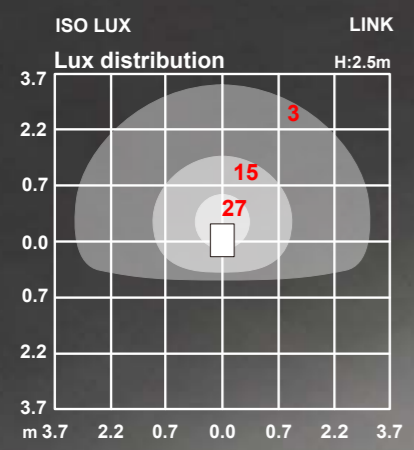

SUNDRESS



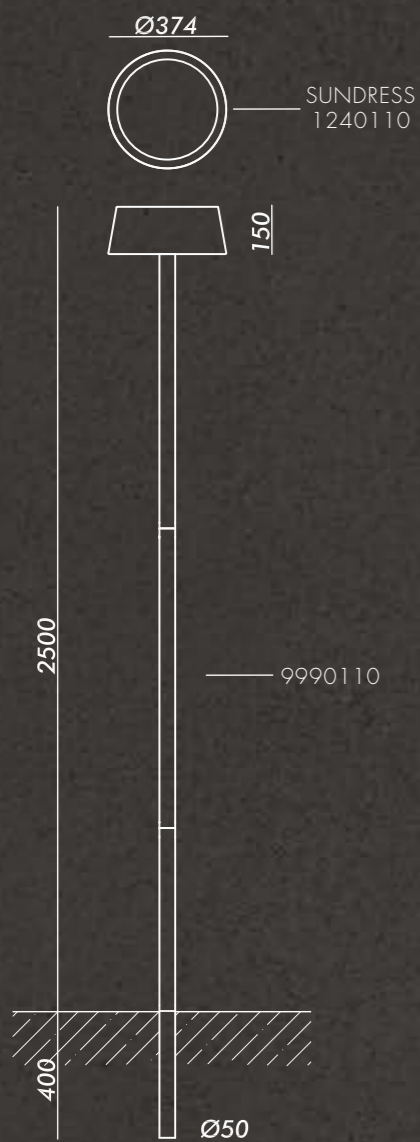

LED solar lamp

Daylight sensor:

- activate at < 50 lux
- turn off at > 50 lux

IP54 ☼ ⚠

Materials:

- die-casting aluminium, extruded aluminium
 - thermosetting epoxy polyester powder coating
 - stainless steel screws
 - spot light: clear glass diffuser
 - pole light: opal polycarbonate diffuser
- Salt spray corrosion test: 800h

Charging time: 8-10h

Working time: 30-32h

Power: 4W

Lithium Battery: 4*2200 mAh (replaceable)

Solar panel:

- 7.5W monocrystalline
- tempered glass

LED: Lumileds 4014

Light colour temperature: 3000K

CRI>80

Inner box size: 44 x 44 x 19.5 cm

Master: 2 pieces

Master size: 45.5 x 40.5 x 45.5 cm

Net weight: 10 kg

Gross weight: 11.1 kg

SUNDRESS

1240110

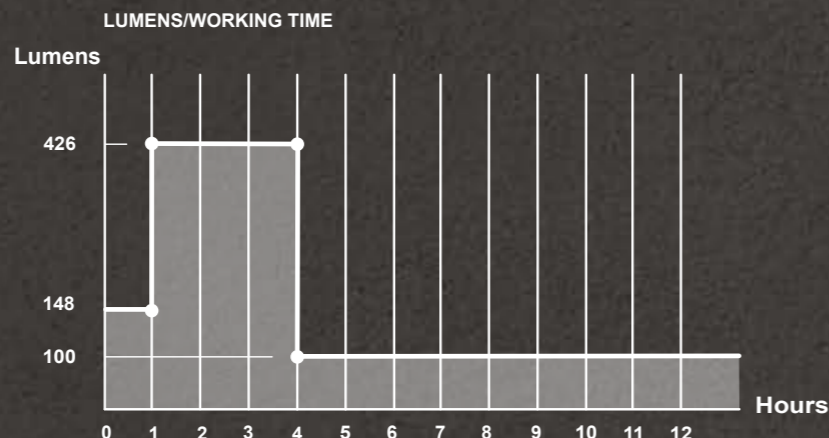
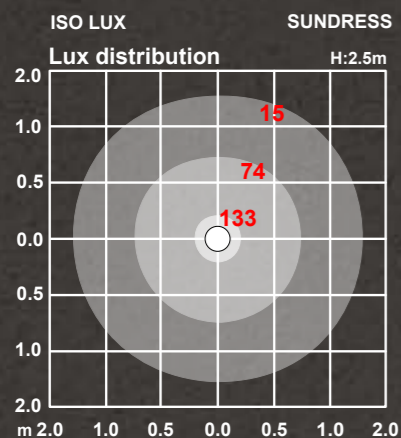
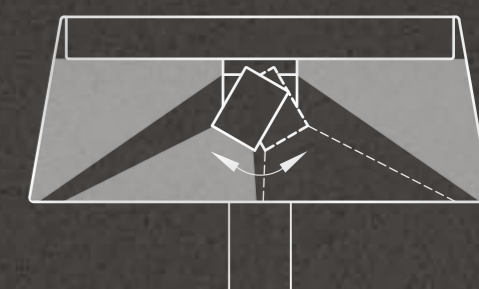



ALEA

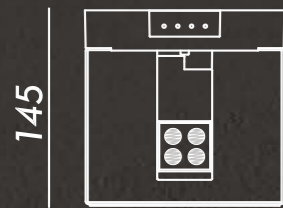
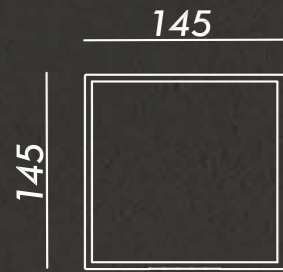

ALEA
1210110

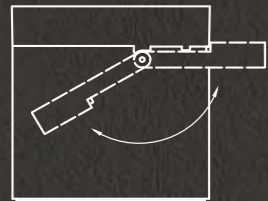

LED solar lamp
Daylight sensor:
- activate at < 50 lux
- turn off at > 50 lux
IP65

Materials:

- die-casting aluminium, extruded aluminium
 - thermosetting epoxy polyester powder coating
 - stainless steel screws
 - clear glass diffuser
- Salt spray corrosion test: 800h

Charging time: 6-8h
Working time: 13-15h
Power: 2.2W
Lithium Battery: 2200 mAh (replaceable)
Battery level indicator
Solar panel:
- 2.5W monocrystalline
- tempered glass
LED: Lumileds 2835
Light colour temperature: 3000K
CRI>80

Inner box size: 20.5 x 20.5 x 23.5 cm
Master: 6 pieces
Master size: 63 x 42.5 x 25 cm
Net weight: 7.2 kg
Gross weight: 9.9 kg

ALEA
1210110



PHOTOMETRIC CURVE ALEA

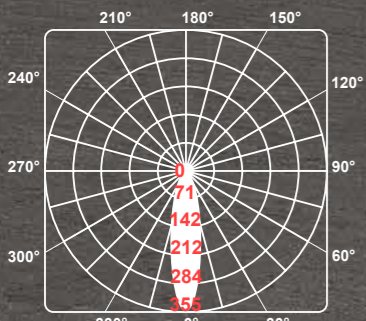

LX DIAM

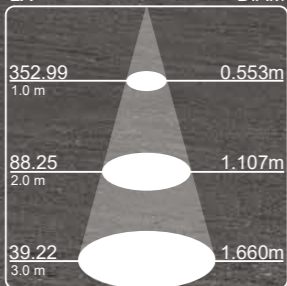

LUMENS/WORKING TIME

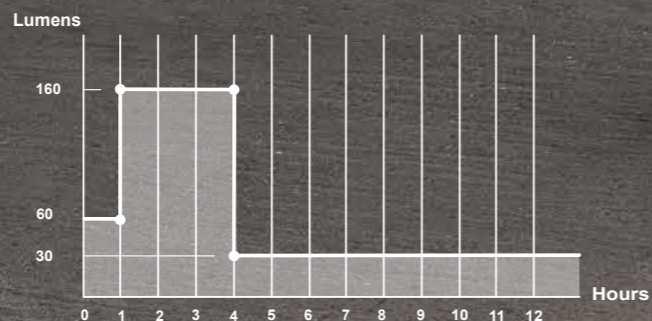

SWING



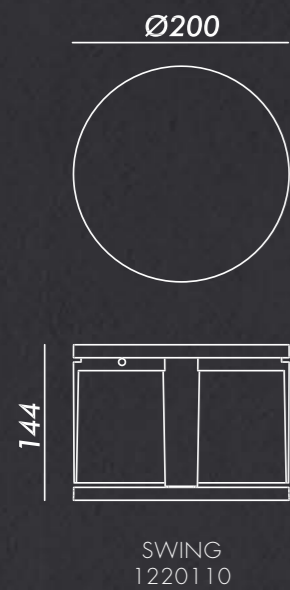

LED solar lamp
Daylight sensor:
- activate at < 50 lux
- turn off at > 50 lux
IP54  

Materials:
- die-casting aluminium
- thermosetting epoxy polyester powder coating
- stainless steel screws
- clear polycarbonate diffuser
Salt spray corrosion test: 800h

Charging time: 10-12h
Working time: 23-25h
Power: 3W
Lithium Battery: 2*2200 mAh (replaceable)
Solar panel:
- 3W monocrystalline
- tempered glass
LED: Lumileds 4014
Light colour temperature: 3000K
CRI>80

Inner box size: 22 x 22 x 22.5 cm
Master: 4 pieces
Master size: 45.5 x 45.5 x 24 cm
Net weight: 8.8 kg
Gross weight: 11.3 kg

SWING
1220110

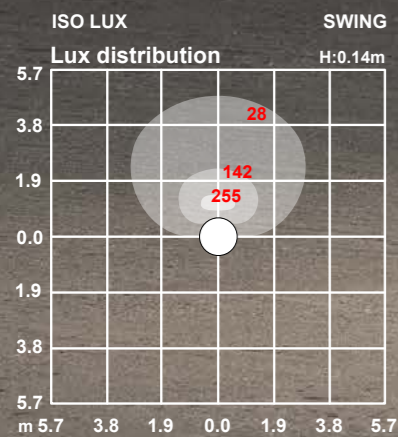



ECOSTEP

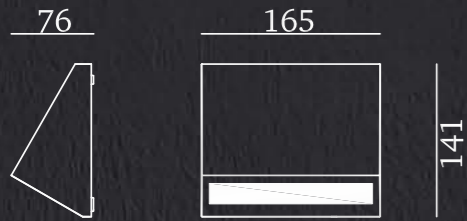



ECOSTEP
1110110



LED solar lamp

Daylight sensor:

- activate at < 50 lux
- turn off at > 50 lux

IP54  

Materials:

- die-casting aluminium
- thermosetting epoxy polyester powder coating
- stainless steel screws
- clear glass diffuser

Salt spray corrosion test: 800h

Charging time: 6-8h

Working time: 13-15h

Power: 2.2W

Lithium Battery: 2200 mAh (replaceable)

Solar panel:

- 2.5W monocrystalline
- tempered glass

LED: Lumileds 4014

Light colour temperature: 3000K

CRI>80

Inner box size: 16 x 9.5 x 19.5 cm

Master: 6 pieces

Master size: 33.5 x 30 x 21 cm

Net weight: 6 kg

Gross weight: 7.5 kg

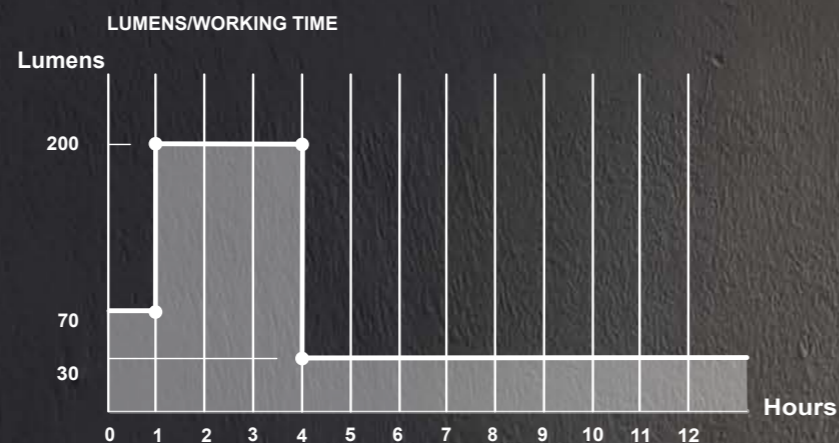
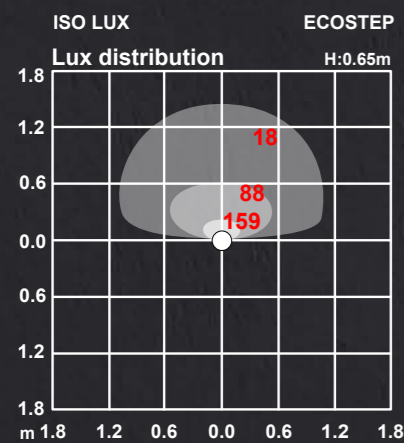

ECOSTEP
1110110



 **KLEWE**
SISTEMASOLARE

Europe Design Distribution s.r.l.

Via Giovanni V. Schiaparelli, 7/B

37135 Verona VR - Italy

Tel: +39 045 2572705

info@eddsrl.eu